

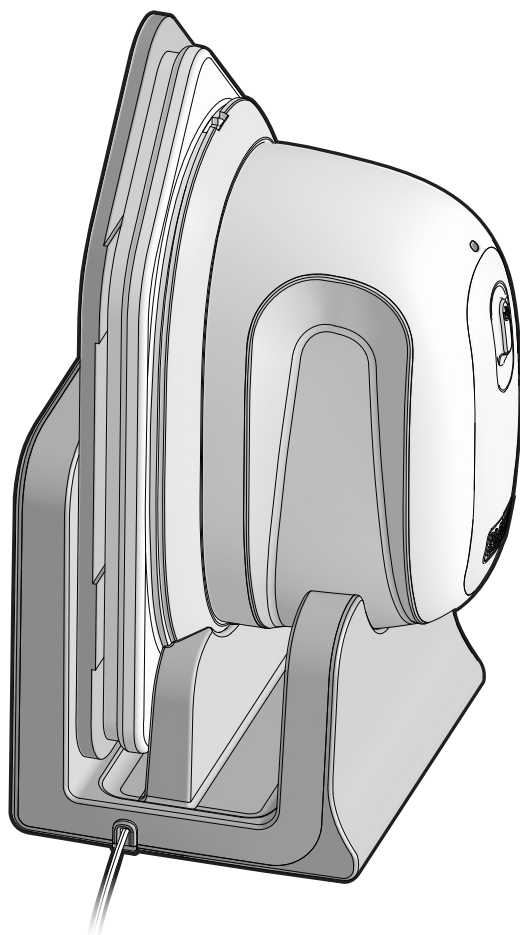

www.blackanddecker.com



BHPC210
BHPC220

ENGLISH
繁體中文

6
10

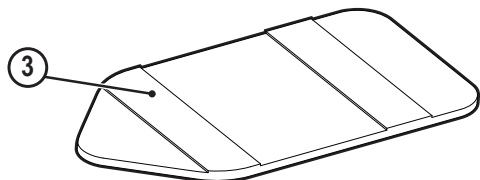
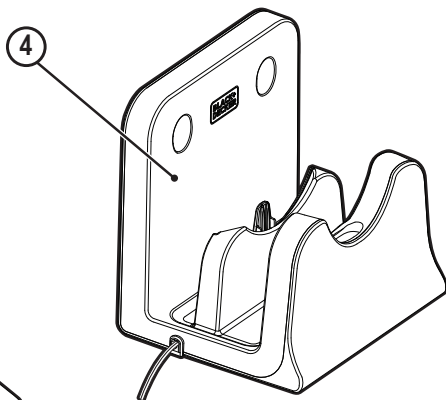
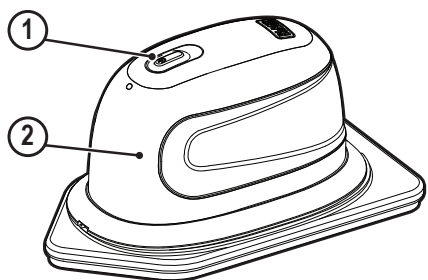

BHPC220

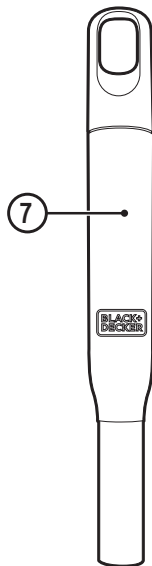
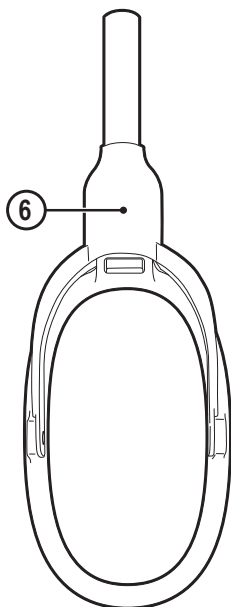
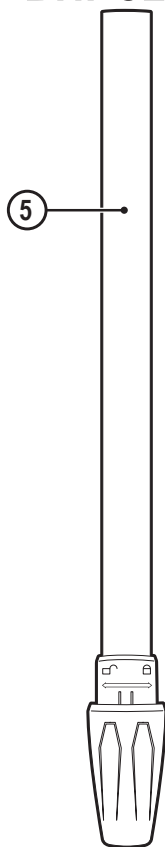

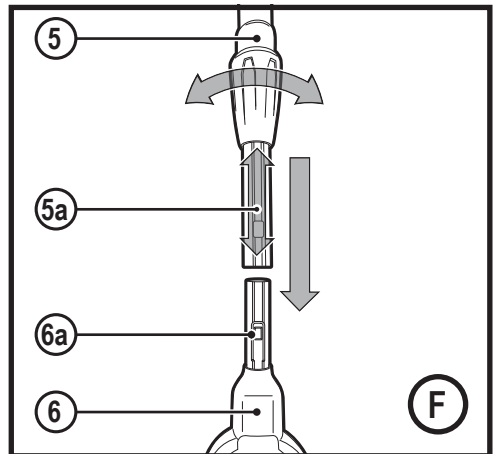
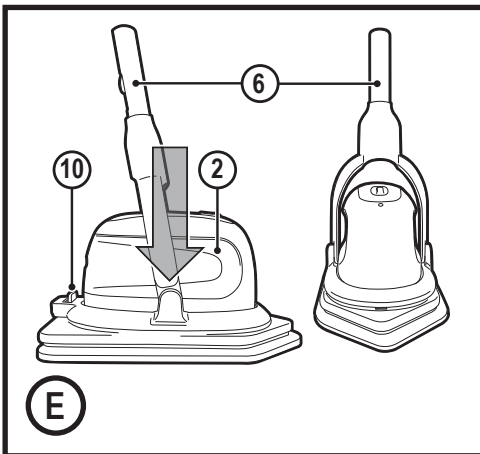
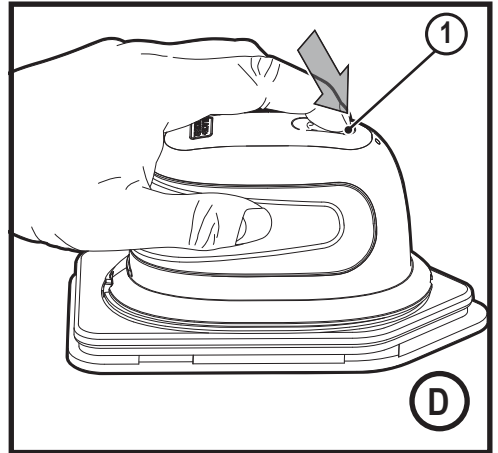
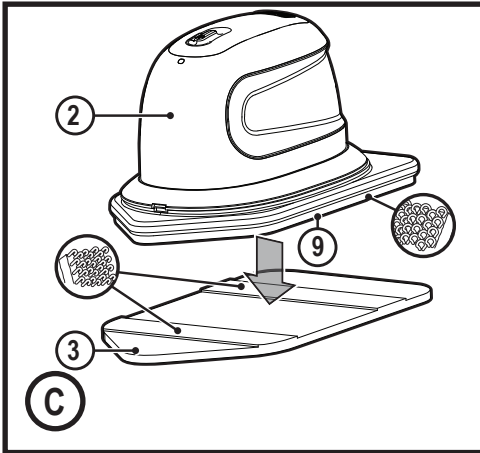
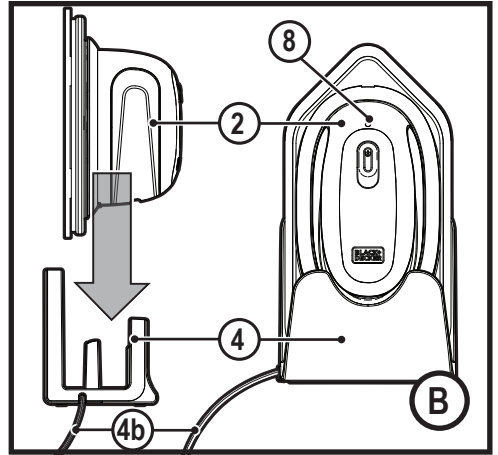
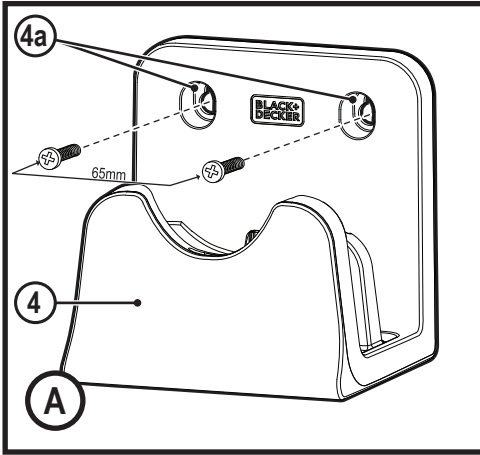

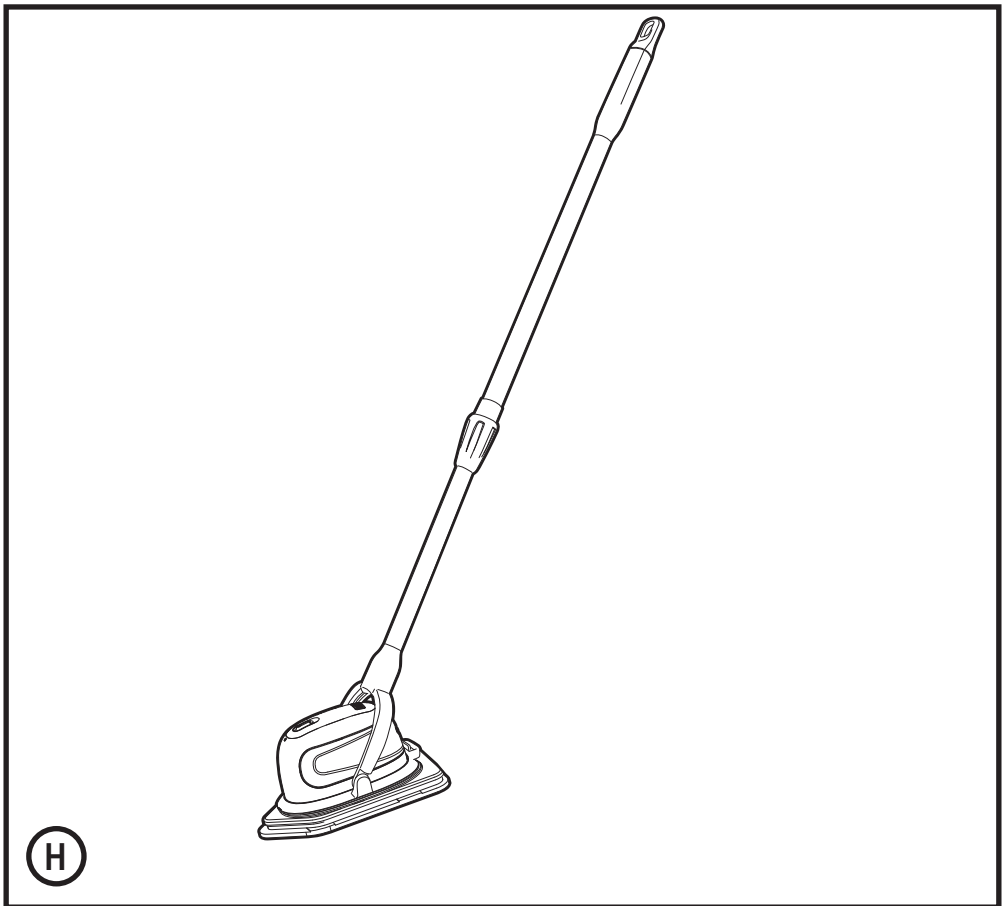
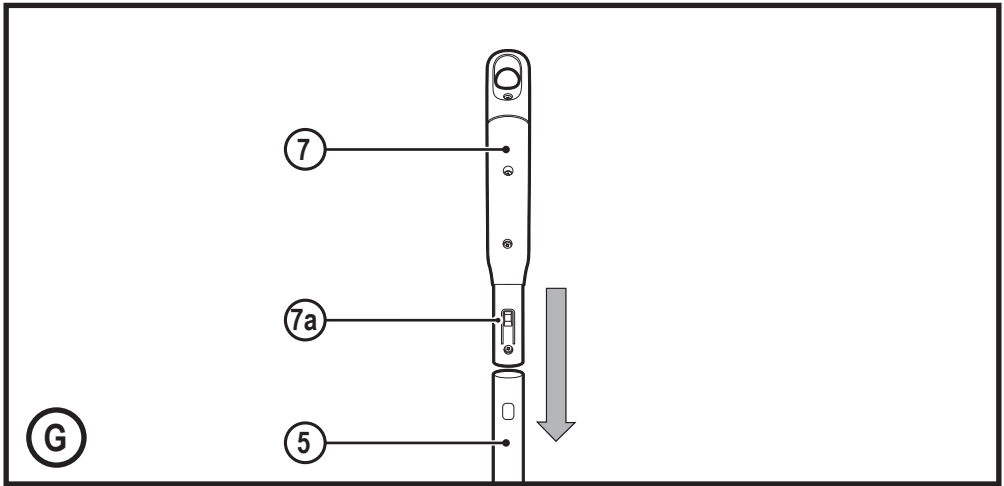

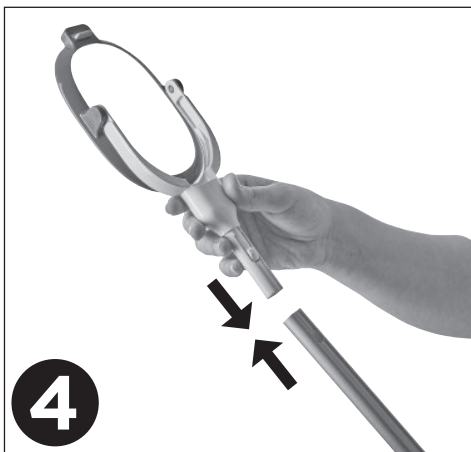
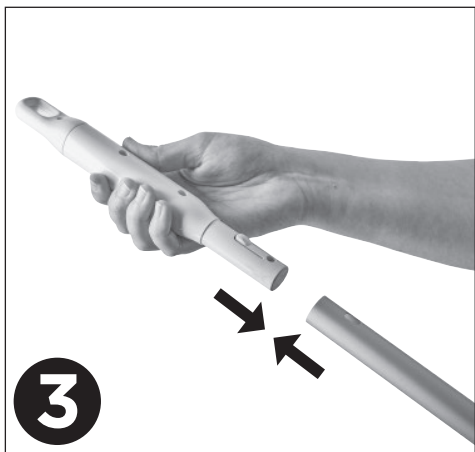
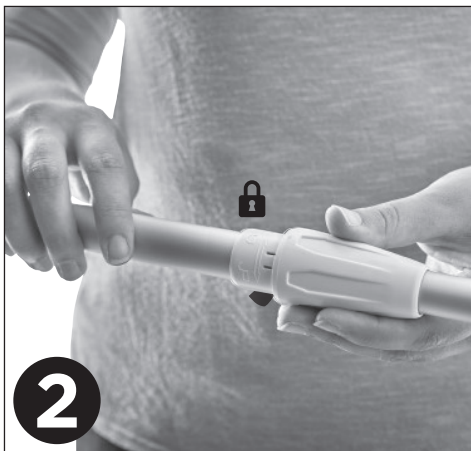
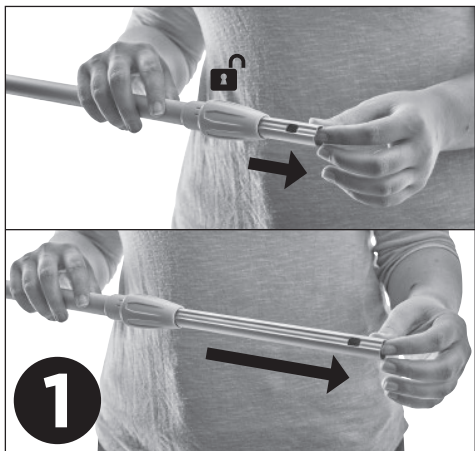

BHPC210, BHPC220 SPEEDY SCRUBBER

Technical Data

| | | BHPC210 | BHPC220 |
|--|----------|------------|------------|
| Voltage | V_{oc} | 3.6 | 3.6 |
| Battery | | Li-Ion | Li-Ion |
| Charger | | SSC-150015 | SSC-150015 |
| Input voltage | V_{in} | 220 | 220 |
| Output voltage | V | 15 | 15 |
| Current | mA | 150 | 150 |
| Capacity | Ah | 1.5 | 1.5 |
| Approx charge time | h | 10 | 10 |
| Weight <small>(without pads & charger base)</small> | Kg | 0.4 | 0.64 |
| Weight of charger base | Kg | 0.19 | 0.19 |
| Class | | III | III |

Intended use

Your BLACK+DECKER BHPC210 and BHPC220 Speedy scrubbers have been designed for cleaning purposes. These appliances are intended for household use only.



Read all of this manual carefully before operating the appliance.

Safety instructions



Warning! Read all safety warnings and all instructions.

Failure to follow the warnings and instructions listed below may result in electric shock, fire and/or serious injury.

- ◆ The intended use is described in this manual. The use of any accessory or attachment or the performance of any operation with this appliance other than those recommended in this instruction manual may present a risk of personal injury.

- ◆ Retain this manual for future reference.

Using your appliance

- ◆ Do not use the appliance to pick up liquids or any materials that could catch fire.
- ◆ Do not use the appliance with ammonia or bleach.
- ◆ Never pull the charger lead to disconnect the charger from the socket. Keep the charger lead away from heat, oil and sharp edges.
- ◆ This appliance can be used by children aged from 8 years and above and persons with reduced physical, sensory or mental capabilities or lack of experience and knowledge if they have been given supervision or instruction concerning use of the appliance in a safe way and understand the hazards involved. Children shall not play with the appliance. Cleaning and user maintenance shall not be made by children without supervision.

Inspection and repairs

Before use, check the appliance for damaged or defective parts.

Check for breakage of parts, damage to switches and any other conditions that may affect its operation.

- ◆ Do not use the appliance if any part is damaged or defective.
- ◆ Have any damaged or defective parts repaired or replaced by an authorized repair agent.

- ◆ Regularly check the charger lead for damage. Replace the charger if the lead is damaged or defective.
- ◆ Never attempt to remove or replace any parts other than those specified in this manual.

Additional safety instructions

After use

- ◆ Unplug the charger before cleaning the charger or charging base.
- ◆ When not in use, the appliance should be stored in a dry place.
- ◆ Children should not have access to stored appliances.

Residual risks

Additional residual risks may arise when using the tool which may not be included in the enclosed safety warnings. These risks can arise from misuse, prolonged use etc.

Even with the application of the relevant safety regulations and the implementation of safety devices, certain residual risks can not be avoided. These include:

- ◆ Injuries caused by touching any rotating/moving parts.
- ◆ Injuries caused when changing any parts, blades or accessories.
- ◆ Injuries caused by prolonged use of a tool. When using any tool for prolonged periods ensure you take regular breaks.
- ◆ Impairment of hearing.
- ◆ Health hazards caused by breathing dust developed when using your

tool (example:- working with wood, especially oak, beech and MDF.)

Chargers

Your charger has been designed for a specific voltage. Always check that the mains voltage corresponds to the voltage on the rating plate.

Warning! Never attempt to replace the charger unit with a regular mains plug.

- ◆ Use your BLACK+DECKER charger only to charge the battery in the appliance with which it was supplied. Other batteries could burst, causing personal injury and damage.
- ◆ Never attempt to charge non-rechargeable batteries.
- ◆ If the supply cord is damaged, it must be replaced by the manufacturer or an authorised BLACK+DECKER Service Centre in order to avoid a hazard.
- ◆ Do not expose the charger to water.
- ◆ Do not open the charger.
- ◆ Do not probe the charger.
- ◆ The appliance/battery must be placed in a well ventilated area when charging.

Electrical safety

Symbols on the charger

 Read all of this manual carefully before using the appliance.

 This tool is double insulated; therefore no earth wire is required. Always check that the power supply corresponds to the voltage on the rating plate.

 The charger is intended for indoor use only.

Labels on appliance

The following symbols appear on this appliance along with the date code.



Read all of this manual carefully before using the appliance

Features

This tool includes some or all of the following features.

1. On/off power switch
2. Main body
3. Cleaning pad
4. Charging station
5. Extendable pole (BHPC220 unit only)
6. Collar (BHPC220 unit only)
7. Handle (BHPC220 unit only)

Charging (Fig. A - B)

Securing charging station to wall

- ◆ Fit the charging station (4) to a suitable wall (preferably near a power outlet) using screws (not provided) as shown in figure A.
- ◆ The unit can then be stored, when not in use, or during the charging procedure as shown in figure B.
- ◆ Whilst charging, the charging indicator light (8) will illuminate.
- ◆ When fully charged the charging indicator light (8) will go off.

Fitting cleaning pad (Fig. C)

- ◆ Place the main body of the unit (2) onto a cleaning pad, ensuring that the 'loop' velcro surface located on the base (9) engages with the 'hook' velcro surface located on the cleaning pad (3), and press down firmly.

Switching on and off (Fig. D)

- ◆ To turn the speedy scrubber on, press the on/off power switch (1).
- ◆ To turn the speedy scrubber off, press the on/off power switch (1) again.

Fitting the collar BHPC220 unit only (Fig. E)

- ◆ Place the collar (6) onto the main body (2) and press down firmly, ensuring that the catch (10) clicks home securely.
- ◆ To remove the collar press the catch (10).

Fitting the extendable pole to the collar BHPC220 unit only (Fig. F)

- ◆ Twist the Lock on the extendable pole (5) in the direction of the 'unlock' position.
- ◆ Allow the extension (5a) to emerge from the extendable

pole.

- ◆ Slot the collar (6) into the extension (5a) until the button (6a) clicks into position.
- ◆ Twist the lock on the extendable pole (5) in the direction of the 'lock' position.

Fitting handle to the extendable pole BHPC220 unit only (Fig. F)

- ◆ Slot the handle (7) into the extendable pole (5) until the button (7a) clicks into position.
- ◆ Adjust to desired height using the lock on the extendable pole as above.

Hints for optimum use

The appliance can be used with a variety of cleaning agents, including sprays, foams, rub-on gels and liquid detergents.

Always read the manufacturer's instructions on the cleaning agent you use. Do not use the appliance with abrasive cleaning agents. Do not use with Bleach or ammonia based cleaning products.



Warning! Wear gloves and eye protection when using aggressive chemical cleaners.

- ◆ If you are unsure about using this appliance on a particular surface, test it first on a small inconspicuous patch.

Cleaning

- ◆ Move the appliance in a circular pattern. Do not hold the appliance in one spot for too long.

Accessories

| | | |
|---|-----------------------|--------------------|
|  | General purpose | BHPC210 BHPC220 |
|  | Abrasive - heavy duty | BHPC210 |
|  | Microfibre | BHPC220 |

Other accessories are available. Please contact your BLACK+DECKER dealer

Maintenance

Your BLACK+DECKER cordless appliance has been designed to operate over a long period of time with a minimum of maintenance. Continuous satisfactory operation depends upon proper tool care and regular cleaning.

Warning! Before performing any maintenance on cordless appliances:

- ◆ Run the battery down completely if it is integral and then switch off.
- ◆ Unplug the charger before cleaning it. Your charger does

not require any maintenance apart from regular cleaning.

- ◆ Regularly clean the ventilation slots in your appliance/charger using a soft brush or dry cloth.
- ◆ Regularly clean the motor housing using a damp cloth. Do not use any abrasive or solvent-based cleaner.

Protecting the environment



Separate collection. Products and batteries marked with this symbol must not be disposed of with normal household waste.

Products and batteries contain materials that can be recovered or recycled reducing the demand for raw materials.

Please recycle electrical products and batteries according to local provisions. Further information is available at www.2helpU.com

Service Information

BLACK+DECKER offers a full network of company-owned and authorized service locations throughout Asia. All BLACK+DECKER Service Centers are staffed with trained personnel to provide customers with efficient and reliable product service.

Whether you need technical advice, repair, or genuine factory replacement parts, contact the BLACK+DECKER location nearest to you.

NOTE

- ◆ BLACK+DECKER's policy is one of continuous improvement to our products and, as such, we reserve the right to change product specifications without prior notice.
- ◆ Standard equipment and accessories may vary by country.
- ◆ Product specifications may differ by country.
- ◆ Complete product range may not be available in all countries. Contact your local BLACK+DECKER dealers for range availability.

BHPC210、BHPC220 電動清潔刷

技術資料

| | | BHPC210 | BHPC220 |
|-------------------|------------------|---------|---------|
| 電壓 | 伏特 _{直流} | 3.6 | 3.6 |
| 電池 | | 鋰離子 | 鋰離子 |
| 輸入電壓 | 伏特 _{交流} | 110 | 110 |
| 輸出電壓 | 伏特 | 15 | 15 |
| 電流 | 毫安 | 150 | 150 |
| 容量 | 安時 | 1.5 | 1.5 |
| 滿電可使用時間 | 分鐘 | 約 60 | 約 60 |
| 大約充電時間 | 小時 | 10 | 10 |
| 重量 (不包括墊及充電底座) | Kg | 0.4 | 0.64 |
| 充電底座重量 | Kg | 0.19 | 0.19 |
| 級別 | | III | III |

請注意！各地區上市產品/配件不盡相同，請依台灣繁體中文說明書的內容為主。

Warning! Attachments and accessories are not the same in each region, please only refer to Taiwan Traditional Chinese description in this manual.

設計用途

您的 BLACK+DECKER BHPC210 及 BHPC220 電動清潔刷專為進行清潔而設計。本工具只供一般 DIY 消費者家庭使用，營業使用者不適用百得一年保修條款。



操作本工具前，請仔細閱讀本手冊全部內容。

安全說明



警告！ 請閱讀所有安全警告及指示。不遵循這些警告和指示可能會導致觸電、火災及/或嚴重傷害。

- ◆ 本手冊描述了工具的設計用途。若使用並非本使用手冊中所建議的配件或附件，或者使用本器具執行並非本使用手冊中所建議的操作，可能會有人身傷害的風險。
- ◆ 請保留本手冊以供日後參考。

使用本工具

- ◆ 請勿使用本工具吸取任何易燃的液體或材料。
- ◆ 請勿將氨或漂白劑配合本工具使用。
- ◆ 請勿直接拉扯電源線以將充電器從插座上拔下。讓充電器遠離熱、油和銳邊。
- ◆ 年滿 8 歲的兒童，以及身體、感覺或心理機能不健全的人員或缺乏經驗及知識的人員，若在針對安全使用本工具的監督或指示之下，並已瞭解所涉及的危險，則可以使用本工具。兒童不得玩耍本工具。請勿在沒有監督的情況下讓小孩對本工具進行清潔和維護。

檢查和維修

使用前，請檢查工具是否有損壞或有故障的零件。

檢查零件破損情況以及可能影響操作的開關損壞和任何其他狀況。

- ◆ 若發現任何零件已損壞或有故障，請勿使用工具。
- ◆ 將所有受損或有故障的零件送往授權的維修中心進行維修或更換。
- ◆ 定期檢查充電器引線是否損壞。如有任何損壞或出現故障，請立即替換。
- ◆ 除了本手冊中指定的零件之外，切勿嘗試卸下任何其他零件或對其進行替換。

請勿交由非百得認證服務中心的技術人員進行修理、維護、調整。若產品經由非百得認證的維修工程師拆解、組裝、調整，恕無法適用百得一年家用保修條款。為充份發揮其功能，修理、維護、調整請務必使用原廠零件。百得認證服務中心擁有保修條款解釋權。

額外安全指示

使用後

- ◆ 清潔充電器或充電底座之前先拔下充電器插頭。
- ◆ 不使用時，應將工具儲存在乾燥的地方。
- ◆ 切勿讓兒童接觸存放的工具。

剩餘風險

使用本工具時，可能會出現隨附安全警告中所不包括的其他剩餘風險。誤用、長時間使用工具等因素會導致這些風險。

即使應用有關的安全規定並採用安全裝置，仍然還有一些無法避免的剩餘風險。

這些風險包括：

- ◆ 接觸旋轉/活動部件引起的傷害。
- ◆ 更換任何部件、刀片或配件引起的傷害。
- ◆ 長時間使用工具引起的傷害。若長時間使用工具，請確保定時休息。
- ◆ 聽力受損。
- ◆ 吸入使用工具時產生的粉塵引起的健康危害（譬如：在木材上使用時，尤其是櫟木、山毛櫸和中密度纖維板（MDF））。

充電器

您的充電器設計用於特定電壓。請務必檢查主電壓是否與銘牌一致。

警告！切勿嘗試使用一般的電源插頭取代充電器裝置。

- ◆ 只能使用工具隨附的 BLACK+DECKER 充電器為工具內的電池充電。其他非原廠電池可能會爆裂，導致人身傷害和損害。
- ◆ 切勿嘗試為不可再充電的電池充電。
- ◆ 若電源線損壞，必須送往製造廠商或授權的 BLACK+DECKER 維修中心更換以避免發生危險。
- ◆ 請勿將充電器暴露在水中。
- ◆ 請勿打開充電器。
- ◆ 請勿刺破充電器。
- ◆ 充電時，必須將工具/電池置放在一個通風良好的地方。

電氣安全

充電器上的符號

 使用工具前，請仔細閱讀本手冊全部內容。

 本工具採用雙重絕緣，因此無需接地線。請務必檢查電源電壓是否與銘牌一致。

 本充電器僅供室內使用。

工具上的標籤

本工具上具有以下圖示與日期代碼。



使用工具前，請仔細閱讀本手冊全部內容。

製造年份及號碼（範例）

| | | |
|------|----|----|
| 2016 | 23 | BM |
| 西元年份 | 週數 | 號碼 |

功能部件

本工具包括以下部分或全部功能部件。

1. 電源開關
2. 主體
3. 清潔墊
4. 充電底座
5. 延長桿（僅限 BHPC220 裝置）
6. 軸環（僅限 BHPC220 裝置）
7. 手柄（僅限 BHPC220 裝置）

充電（圖 A - B）

- ◆ 如圖 A 所示，使用螺絲（需另購）將充電底座 (4) 安裝到合適的牆壁上（最好接近電源插座）。
- ◆ 如此便可在不使用或為裝置充電時，妥善存放裝置（如圖 B 所示）。
- ◆ 充電期間，充電指示燈 (8) 將持續亮起。
- ◆ 電力全滿後，充電指示燈 (8) 將熄滅。
- ◆ 在電池用完電量後，建議馬上充電，鋰電池請勿過度放電，電力過度耗竭會導致鋰電池損壞。
- ◆ 若長時間未使用電池（1 年以上），請每 6 個月為電池充電一次，以確保電池壽命。
- ◆ 當主機突然停止動作，或無法完成以往的作業量時，請馬上充電。

安裝清潔墊（圖 C）

- ◆ 將裝置主體 (2) 放在清潔墊上，並確保底座 (9) 上的魔鬼氈貼面貼到清潔墊 (3) 上的魔鬼氈貼面，然後向下按緊。

開啟和關閉電源（圖 D）

- ◆ 若要啟動清潔刷頭，請按下電源開關 (1)。
- ◆ 若要關閉清潔刷頭，請再次按下電源開關 (1)。

安裝軸環（僅限 BHPC220 裝置）（圖 E）

- ◆ 將軸環 (6) 放在主體 (2) 上並向下按緊，同時確保鎖門 (10) 卡入到位。
- ◆ 如要卸下軸環，請按一下鎖門 (10)。

安裝延長桿到軸環 (僅限 BHPC220 裝置) (圖 F)

- ◆ 將延長桿 (5) 上的鎖朝「解鎖」位置轉動。
- ◆ 允許延伸部分 (5a) 從延長桿上露出。
- ◆ 將軸環 (6) 插入延伸部分 (5a)，直到按鈕 (6a) 卡入到位。
- ◆ 將延長桿 (5) 上的鎖朝「鎖定」位置轉動。

將手柄安裝至延長桿 (僅限 BHPC220 裝置) (圖 F)

- ◆ 將手柄 (7) 插入延長桿 (5)，直到按鈕 (7a) 卡入到位。
- ◆ 使用延長桿上的按鈕 (如上述) 調整至所需高度。

最佳使用提示

本工具可配合多種清潔劑使用，包括噴霧、泡沫、摩擦凝膠及液體清潔劑。

請務必閱讀清潔劑製造商提供的說明。請勿將本工具配合磨蝕性清潔劑使用。請勿使用含漂白劑或氨的清潔產品。

警告! 使用侵蝕性清潔劑時，請佩帶手套及護目裝備。

- ◆ 如果您不確定應否在特定的表面上使用本工具，請先在不明顯處小範圍進行測試。

警告! 應在深度不超過 20 公分及溫度不超過 30°C 的環境下使用裝置，並且每次不應使用裝置超過 30 分鐘。

清潔

- ◆ 以打圈方式移動工具。不要長時間將工具放置於一個點上。

配件

| | | |
|--|----------|---------------|
|  | 一般用途，通用型 | 配件型號：BHPC200A |
|  | 頑強污垢，菜瓜布 | 配件型號：BHPC201A |
|  | 超細纖維，軟毛布 | 配件型號：BHPC202A |

提供其他配件。請聯絡您當地的 BLACK+DECKER 代理商。

維護

您的 BLACK+DECKER 充電式工具採用卓越的設計，能夠長時間使用，並且只需最少的維護。若要持續獲得滿意的操作效果，需進行正確的工具維護和定期的清潔。

警告! 在充電式工具上執行任何維護工作之前：

- ◆ 若電池屬於內建電池，請使電池完全放電，然後再關閉電源。
- ◆ 清潔之前請拔下充電器的插頭。您的充電器除了定期清潔之外，並不需要執行任何維護操作。
- ◆ 定期使用軟刷或乾布清潔工具/充電器內的通風槽。
- ◆ 定期使用濕布清潔電動機外殼。請勿使用任何研磨性或溶劑型清潔劑。

保護環境



分類回收。帶有此標誌的產品和電池必須與一般家庭廢物分開處置。

產品和電池包含可重複使用或回收的材料，可降低對原材料的需求。

請根據當地法規回收電氣產品和電池。更多資訊，請造訪 www.2helpU.com。

維修資訊

BLACK+DECKER 提供遍佈亞洲的公司隸屬及授權服務地點。所有的 BLACK+DECKER 服務中心都具有訓練有素的人員，為客戶提供高效、可靠的產品服務。

不論您需要的是技術建議、維修服務還是原廠正品替換零件，都可以聯絡距您最近的 BLACK+DECKER 服務地點。

附註

- ◆ BLACK+DECKER 的政策是持續改善我們的產品，因此，我們保留隨時變更產品規格的權利，恕不另行通知。
- ◆ 標準裝置和配件可能會根據不同的國家/地區而有所不同。
- ◆ 產品規格可能會根據不同的國家/地區而有所不同。
- ◆ 並非所有的國家/地區都將提供完整的產品系列。如需各產品系列的供應情況，請聯絡您當地的 BLACK+DECKER 代理商。

進口/委製廠商：新加坡商百得電動工具(股)公司台灣分公司

地址：台北市士林區德行西路 33 號 2 樓

電話：02-2834-1741